

Distributed by:

JAMECO[®]
ELECTRONICS

www.Jameco.com ♦ 1-800-831-4242

The content and copyrights of the attached
material are the property of its owner.

Jameco Part Number 1851296

concave termination with square corners resistor array



features

- Manufactured to type RK73 standards
- Less board space than individual chips
- Isolated resistor elements
- Marking: Marked with resistance value
- Products with lead-free terminations meet EU RoHS requirements. Pb located in glass material, electrode and resistor element is exempt per Annex 1, exemption 5 of EU directive 2005/95/EC

dimensions and construction

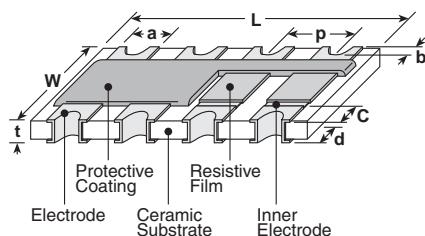

Size Code	Dimensions inches (mm)								
	L	W	C	d	t	a (top)	a (bot.)	b	p (ref.)
1J2	.063±.006 (1.6±0.15)								
1J4	.126±.008 (3.2±0.2)	.063±.006 (1.6±0.15)	.012±.006 (0.3±0.15)	.016±.006 (0.4±0.15)		.020±.006 (0.5±0.15)	.016±.006 (0.4±0.15)		.031 (0.8)
1J8	.252±.008 (6.4±0.2)								
2A2	0.1±.008 (2.54±0.2)								
2A4	0.2±.008 (5.08±0.2)	.079±.008 (2.0±0.2)	.016±.008 (0.4±0.2)		.024±.004 (0.6±0.1)			.006 (0.15)	
2A8	0.4±.008 (10.16±0.2)			.022±.006 (0.55±0.15)		.031 (0.8)	.030±.006 (0.75±0.15)		.050 (1.27)
2B2	0.1±.008 (2.54±0.2)								
2B4	0.2±.008 (5.08±0.2)	.126±.008 (3.2±0.2)	.020±.012 (0.5±0.3)						
2B8	0.4±.008 (10.16±0.2)								

ordering information

New Part #	CN	1J	4	T	TD	101	J
Type				Termination Material	Packaging	Nominal Resistance	Tolerance
		Size	Elements	T: Sn (Other termination styles may be available, please contact factory for options)	TE: 7" embossed plastic TD: 7" paper tape TED: 10" embossed plastic TDD: 10" paper tape	2 significant figures + 1 multiplier for ±2 & ±5% 3 significant figures + 1 multiplier for ±1%	F: ±1% G: ±2% J: ±5%

For further information on packaging, please refer to Appendix A.

circuit schematic

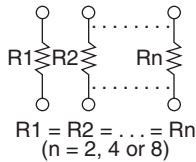

applications and ratings

Part Designation	Power Rating @ 70°C (Per Element)	T.C.R. (ppm/°C) Max.	Resistance Range (Ω)			Absolute Maximum Working Voltage	Maximum Overload Voltage (5 Secs. Max.)	Operating Temperature Range
			E-24, E-96 (F:±1%)	E-24 (G:±2%)	E-24 (J:±5%)			
CN1J2	1/16W (.063W)	±200: R≥10Ω	10 - 1M	10 - 1M	10 - 1M	50V	100V	-55°C to +125°C
CN1J4					1 - 1M			
CN1J8					1 - 1M			
CN2A2	1/10W (.100W)	±400: R<10Ω	10 - 1M	10 - 1M	10 - 1M	100V	200V	
CN2A4					—			
CN2A8					—			
CN2B2	1/8W (.125W)	±400: R<10Ω	10 - 1M	—	200V	200V	400V	
CN2B4					—			
CN2B8					—			

environmental applications

Derating Curve

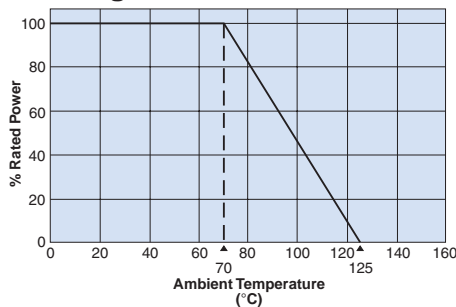

Surface Temperature Rise

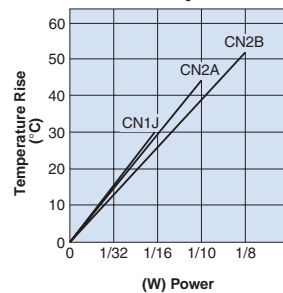

Performance Characteristics

Parameter	Maximum Δ R	Test Method
Thermal Shock	±(1.0% + 0.1Ω)	MIL-STD-202, Method 107, -55°C to +125°C, 5 cycles
Low Temperature Operation		MIL-R-55342 π 4.7.4, 1 hour @ -55°C followed by 45 minutes of RCWV*
High Temperature Exposure		MIL-R-55342 π 4.7.6, 100 hours @ 125°C
Short Time Overload	±(2.0% + 0.05Ω)	MIL-R-55342 π 4.7.5, 2.5 x RCWV for 5 seconds
Resistance to Solder Heat	±(1.0% + 0.1Ω)	MIL-R-55342 π 4.7.7, 260°C for 10 seconds
Terminal Strength-Push		1.2 Kg for 1 minute
Terminal Strength-Bend	±(0.5% + 0.05Ω)	5mm deflection in either direction for 10 seconds
Moisture Resistance	±5.0%	MIL-STD-202, Method 103, 40°C, 90 - 95% RH, 1000 hours
Life		MIL-STD-202, Method 108, 70°C, 1000 hours @ RCWV, 1.5 hr ON, 0.5 hr OFF
Pulse		2.5 x RCWV, not exceeding max. overload voltage, 1 sec. ON, 25 sec. OFF, 10,000 cycles
Temperature Cycling	±1.0%	30 min. @ -55°C, 15 min. @ +25°C, 30 min. @ +125°C, 15 min. @ +25°C, 5 cycles
Terminal Adhesion	15 Grams Minimum	Axial pull, one terminal at a time
Dielectric Withstanding Voltage CN1J, CN2A, CN2B	100V, 400V, 400V	1 minute minimum MIL-STD-202, Method 301
Insulation Resistance	1,000 MΩ Minimum	—

* RCWV = Rated Continuous Working Voltage.

Type	Component Size (mm)			Carrier Tape	Quantity/ Reel (Pieces)	Taping (mm)					Reel Size	
	L	W	T			A	B	W	P1	T1		
RK73B RK73H RK73-RT RK73G RK73A RK73Z SG73 RK73N SR73 RF73 UR73 RN73 LT73 HV73 RN73H SG73P SG73S SG73-RT	1F	0.4	0.2	0.12	TB	10000	0.45±0.03	0.25±0.03	8.0±0.2	2±0.05	0.31+0.2/-0	178
	1H	0.6	0.3	0.23	TC	10000	0.67±0.05	0.37±0.05	8.0±0.2	2±0.05	0.42+0.2/-0	178
	1E	1	0.5	0.35	TP	10000	1.15±0.1	0.65±0.1	8.0±0.2	2±0.05	0.45+0.2/-0	178
	1J	1.6	0.8	0.45	TP	10000	1.9±0.1	1.1±0.1	8.0±0.2	2±0.05	0.6+0.2/-0	178
					TD	5000	1.9±0.1	1.1±0.08	8.0±0.2	4.0±0.1	0.6+0.2/-0	178
					TDD	10000	1.9±0.1	1.1±0.1	8.0±0.2	4.0±0.1	0.6+0.2/-0	255
	2A	2	1.25	0.5	TP	10000	2.4±0.2	1.65±0.2	8.0±0.2	2±0.05	0.75+0.2/-0	178
					TD	5000	2.4±0.2	1.65±0.2	8.0±0.2	4.0±0.1	0.75+0.2/-0	178
					TE	4000	2.4±0.2	1.6±0.2	8.0±0.2	4.0±0.1	0.9±0.1	178
					TDD	10000	2.4±0.1	1.65±0.1	8.0±0.2	4.0±0.1	0.75+0.2/-0	255
					TED	10000	2.4±0.2	1.45±0.15	8.0±0.2	4.0±0.1	0.65±0.1	255
	2B	3.2	1.6	0.6	TD	5000	3.5±0.2	2±0.2	8.0±0.2	4.0±0.1	0.75+0.2/-0	178
					TE	4000	3.5±0.2	1.9±0.2	8.0±0.2	4.0±0.1	1.0±0.1	178
					TDD	10000	3.5±0.1	1.9±0.1	8.0±0.2	4.0±0.1	0.75+0.2/-0	255
					TED	10000	3.5±0.1	1.9±0.2	8.0±0.2	4.0±0.1	1.0±0.1	255
2E	3.2	2.6	0.6	TD	5000	3.5±0.2	2.85±0.2	8.0±0.2	4.0±0.1	0.75+0.2/-0	178	
				TE	4000	3.5±0.2	2.85±0.2	8.0±0.2	4.0±0.1	1.0±0.15	178	
				TDD	10000	3.5±0.1	2.8±0.1	8.0±0.2	4.0±0.1	0.75+0.2/-0	255	
				TED	10000	3.6±0.15	2.9±0.15	8.0±0.2	4.0±0.1	1.0±0.1	255	
2H	5	2.5	0.6	TE	4000	5.35±0.2	2.9±0.2	12.0±0.1	4.0±0.1	1.0±0.15	178	
				TED	10000	5.4±0.2	2.9±0.2	12.0±0.1	4.0±0.1	0.85±0.1	255	
				TE	4000	6.65±0.2	3.44±0.2	12.0±0.1	4.0±0.1	1.0±0.15	178	
3A	6.3	3.1	0.6	TED	10000	6.9±0.2	3.6±0.2	12.0±0.1	4.0±0.1	0.85±0.1	255	
				TE	4000	5.35±0.5	2.9±0.2	12.0±0.3	4.0±0.1	1±0.15	178	
				TE	4000	4.85±0.2	3.35±0.2	12.0±0.3	4.0±0.1	1±0.15	178	
WK73	2H	2.5	5.0	0.4	TE	4000	6.65±0.2	3.44±0.2	12.0±0.3	4.0±0.1	1±0.15	178
	2J	3.1	4.6	0.4	TE	4000	4.85±0.2	3.35±0.2	12.0±0.3	4.0±0.1	1±0.15	178
	3A	3.1	6.4	0.45	TE	4000	6.65±0.2	3.44±0.2	12.0±0.3	4.0±0.1	1±0.15	178
CND	2B10	6.40	3.1	0.6	TE	4000	6.6±0.2	3.4±0.2	12.0±0.1	4.0±0.1	1±0.15	178
	1J10	3.20	1.6	0.55	TD	5000	3.5±0.1	2.0±0.1	8.0±0.2	4.0±0.1	0.75+0.2/-0	178
	2A10	4.00	2.1	0.6	TE	4000	4.45±0.2	2.5±0.2	12.0±0.1	4.0±0.1	1±0.15	178
CNB	2B5Z	3.2	2.5	0.6	TE	4000	3.5±0.2	3.0±0.2	8.0±0.2	4.0±0.1	1±0.15	178
	2E9Z	6.40	3.2		TE	4000	6.7±0.2	3.5±0.2	12.0±0.1	4.0±0.1	1±0.15	178

Bulk Case (RK73 1E, 1J, 2A, 2B) Packaging Designation: BK

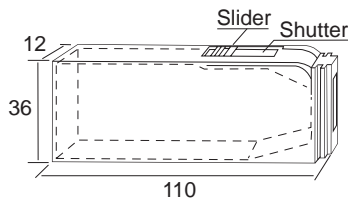

Style	Packaging Quantity
1E	50,000 pieces/case
1J	25,000 pieces/case
2A	10,000 pieces/case
2B	5,000 pieces/case

Packaging specifications

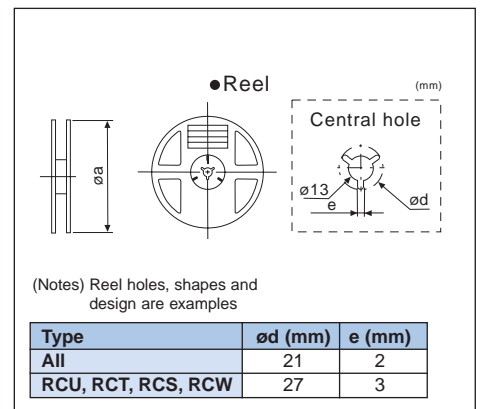
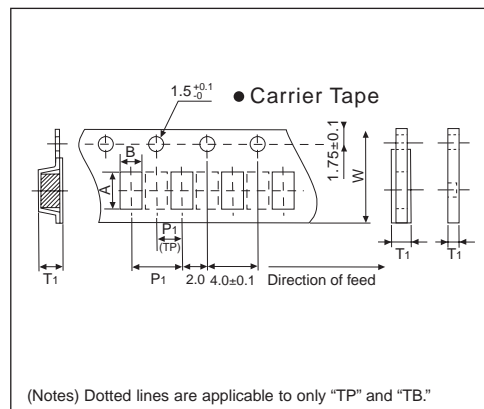

Type	Component Size (mm)			Carrier Tape	Quantity/ Reel (Pieces)	Taping (mm)					Reel Size		
	L	W	T			A	B	W	P1	T1			
CN CN_A CN_K/N CNZ CNN	1F8	3.8±0.1	1.6±0.2	0.44±0.1	TP	5000	4.0±0.1	1.8±0.1	8.0±0.2	2.0±0.05	0.55±0.1	178	
	1E2K	1.00	1	0.35	TP	10000	1.2±0.1	1.2±0.1	8.0±0.2	2.0±0.05	0.45±0.1	178	
	1E4/1E4K	1.60	1.6	0.6/0.5	TP	10000	2.2±0.1	1.2±0.1	8.0±0.2	2.0±0.5	0.45±0.1	178	
	1J2/1J2K				TD	5000	1.9±0.1	1.9±0.1	8.0±0.2	4.0±0.1	0.6+0.2/-0 0.75+0.2/-0/	178	
	1J4/1J4KA	3.20	1.6	0.6/0.5	TDD	10000	1.9±0.1	1.1±0.1	8.0±0.2	4.0±0.1	0.6+0.2/-0 0.75+0.2/-0/	255	
					TD	5000	3.5±0.1	2.0±0.1	8.0±0.2	4.0±0.1	0.75+0.2/-0/	178	
	1J8	6.40	1.6	0.6	TDD	10000	1.9±0.1	1.1±0.1	8.0±0.2	4.0±0.1	0.75+0.2/-0 0.6+0.2/-0/	255	
					TE	4000	6.9±0.2	2.0±0.2	12.0±0.1	4.0±0.1	0.9±0.1	178	
	2A2	2.54	2	0.6	TED	10000	6.9±0.2	2.0±0.2	12.0±0.1	4.0±0.1	0.9±0.1	255	
					TE	4000	2.9±0.2	2.4±0.2	8.0±0.2	4.0±0.1	1±0.15	178	
	2A4	5.08	2	0.6	TED	10000	2.9±0.2	2.4±0.2	8.0±0.2	4.0±0.1	1±0.15	255	
					TE	4000	5.4±0.2	2.3±0.2	12.0±0.1	4.0±0.1	1±0.15	178	
	2A8	10.16	2	0.6	TED	10000	5.4±0.2	2.3±0.2	12.0±0.1	4.0±0.1	1±0.15	255	
					TE	4000	10.6±0.2	2.45±0.2	16	4.0±0.1	1±0.15	178	
	2B2	2.54	3.2	0.6	TED	10000	10.6±0.2	2.45±0.2	16	4.0±0.1	1±0.15	255	
TE					4000	3.5±0.2	2.85±0.2	8.0±0.2	4.0±0.1	1±0.15	178		
2B4	5.08	3.2	0.6	TED	10000	3.5±0.2	2.85±0.2	8.0±0.2	4.0±0.1	1±0.15	255		
				TE	4000	5.4±0.2	3.4±0.2	12.0±0.1	4.0±0.1	1±0.15	178		
2B8	10.16	3.2	0.6	TED	10000	5.4±0.2	3.4±0.2	12.0±0.1	4.0±0.1	1±0.15	255		
				TE	2000	10.55±0.2	3.6±0.2	16	4.0±0.1	1±0.15	178		
RD41B RN41 RM41 MLT CC	2A	2	1.25	-	TED	5000	10.55±0.2	3.6±0.2	16	4.0±0.1	1±0.15	255	
					TE	3000	2.4±0.2	1.5±0.2	8.0±0.2	4.0±0.1	1.45±0.2	178	
	2B	3.5	1.45	-	TED	10000	2.4±0.2	1.5±0.2	8.0±0.2	4.0±0.1	1.45±0.2	255	
					TE	3000	3.7±0.2	1.7±0.2	8.0±0.2	4.0±0.1	1.7±0.2	178	
	2D	3.2	1.55	-	TED	10000	3.7±0.2	1.7±0.2	8.0±0.2	4.0±0.1	1.7±0.2	255	
					TE	2000	3.7±0.2	1.7±0.2	8.0±0.2	4.0±0.1	1.7±0.2	178	
	2E, 2H, 3AS	5.9	2.2	-	TED	1500	6.2±0.2	2.4±0.2	12.0±0.1	4.0±0.1	2.6±0.2	178	
					TE	10000	6.2±0.2	2.4±0.2	12.0±0.1	4.0±0.1	2.6±0.2	255	
	NT73 LA73 LT73	1E	1	0.5	0.35	TP	10000	1.15±0.1	0.65±0.1	8.0±0.2	2.0±0.05	0.45+0.1/-0	178
		1J	1.6	0.8	0.45	TD	5000	1.9±0.1	1.1±0.1	8.0±0.2	4.0±0.1	0.6+0.2/-0	178
		2A	2	1.25	0.5	TD	5000	2.4±0.2	1.65±0.2	8.0±0.2	4.0±0.1	0.75+0.2/-0	178
		2B	3.2	1.6	0.6	TD	5000	3.5±0.2	2±0.2	8.0±0.2	4.0±0.1	0.75+0.2/-0	178
	PT72	2A	2	1.25	1	TE	3000	2.25±0.1	1.45±0.1	8.0±0.2	4.0±0.1	1.5±0.15	178
		2B	3.2	1.6	1	TE	3000	3.5±0.2	1.9±0.2	8.0±0.2	4.0±0.1	1.5±0.15	178
	SDT73H SDT73V	2B	3.2	1.6	0.5	TE	5000	3.6±0.1	2.0±0.1	8.0±0.2	4.0±0.1	0.85+0.05/-0.1	178
LP73	1J	1.6	0.8	0.5	TE	5000	1.9±0.1	1.1±0.1	8.0±0.2	4.0±0.1	0.6±0.1	178	
	2A	2.0	1.25	0.5	TE	5000	2.4±0.1	1.6±0.1	8.0±0.2	4.0±0.1	0.85±0.1	178	
	2B	3.2	1.6	0.5	TE	5000	3.6±0.1	2.0±0.2	8.0±0.2	4.0±0.1	0.85±0.1	178	
RCU	1.60	0.8	1.15	-	TE	2000	1.85±0.16	1.05±0.15	8.0±0.2	4.0±0.1	1.25±0.1	178	
					TED	5000	1.85±0.16	1.05±0.15	8.0±0.2	4.0±0.1	1.25±0.1	255	
RCT	2.00	1.25	1.45	-	TE	2000	2.45±0.15	1.65±0.1/	8.0±0.2	4.0±0.1	1.70±0.1	178	
					TED	5000	2.45±0.15	1.65±0.1/	8.0±0.2	4.0±0.1	1.70±0.1	255	
RCS	3.20	1.6	1.25	-	TE	2000	3.6±0.2	2.0±0.2	8.0±0.2	4.0±0.1	1.45±0.15	178	
					TED	5000	3.6±0.2	2.0±0.2	8.0±0.2	4.0±0.1	1.45±0.15	255	
RCW	3.2	1.6	2	-	TE	2000	3.4±0.1/ -0.05	1.95±0.1/ -0.05	8.0±0.2	4.0±0.1	2.2±.01	178	
KL32	3.2	2.5	2.2	-	TE	2000	3.55±0.1	2.70±0.1	8.0±0.1	4.00±0.1	2.7±0.5	178	
KL73	1H	0.6	0.3	0.23	TB	10000	0.67±0.05	0.37±0.05	8.0	2.0	0.42+0.2/-0	178	
	1E	1	0.5	0.35	TP	10000	1.15±0.1	0.65±0.1	8.0±0.2	2.0±0.05	0.45±0.2	180	
	1J	1.6	0.8	0.5	TE	4000	1.9±0.1	1.1±0.1	8.0±0.2	4.0±0.1	0.9±0.15	180	
	2A	2	1.25	0.5	TE	4000	2.4±0.2	1.6±0.2	8.0±0.2	4.0±0.1	1.0±0.15	180	
KQ KQC KQT	2B	3.2	1.6	10.6	TE	4000	3.5±0.2	1.9±0.2	8.0±0.2	4.0±0.1	1.0±0.15	180	
	0402	1.10	0.5	0.5	TD	2000	1.22±0.05	0.73±0.05	8.0±0.2	4.0±0.1	0.65±0.1	180	
	0603	1.60	1	0.9	TE	2000	1.72±0.05	1.07±0.05	8.0±0.2	4.0±0.1	1.2±0.1	180	
	0805	2.00	1.5	1.3	TE	2000	2.22±0.1	1.6±0.1	8.0±0.2	4.0±0.1	1.65±0.1	180	
LPC	1008	2.50	2.2	1.8	TE	2000	2.7±0.1	2.35±0.1	8.0±0.2	4.0±0.1	2.2±0.1	180	
	4045	4.50	4	4.5	TED	1000	4.158±0.2	4.75±0.2	12.0±0.1	8.0±0.2	5±0.2	380	
	4235	4.5	4.2	3.5	TE	2000	4.4±0.2	4.75±0.2	12.0±0.1	8.0±0.1	4.0±0.2	330	
	9040N	9.00	10.2	4.9	TED	500	Ø9.4±0.2	—	16±.01	12±.01	7.5±0.2	380	
	12065	12.40	12	7.5	TED	300	12.5±0.2	13±0.2	24±.01	16±.02	8.2±0.2	380	
SDR	10065	10.40	10	7.5	TED	300	11±0.2	111.5±0.2	24±.01	16±.02	8.2±0.2	380	
	0604	5.6	—	4.5	TE	1500	—	—	12	4.0±0.1	5.0	330	
	0805	7.8	—	5.3	TE	1000	—	—	—	12.0	6.2	380	
	1006	9.8	—	5.8	TE	800	—	—	—	12.0	6.7	380	

Specifications given herein may be changed at any time without prior notice. Please confirm technical specifications before you order and/or use.

2/27/08

Type		Component Size (mm)			Carrier Tape	Quantity/ Reel (Pieces)	Taping (mm)					Reel Size
		L	W	T			A	B	W	P1	T1	
SL	1	6.3	3.1	1.9	TE	1000	6.8±0.1	3.6±0.1	12.0±0.1	8.2±0.2	2.35±0.1	180
	2/3	11.5	7	2.5	TED	1000	12.2±0.1	7.7±0.1	24	12.0±0.1	3.1±0.1	255
SLN	2	11.5	7	2.5	TE	1000	12.2±0.1	7.7±0.1	12.0±0.1	12±0.2	3.1±0.1	225
TLR	3A, 3AW	6.4	3.2	0.6	TE	2000	6.75±0.2	3.55±0.1	12.0±0.1	8.0±0.2	1.0±0.1	180
	2B, 2BN	3.2	1.6	0.6	TD	5000	3.5±0.2	2.0±0.2	8.0±0.2	4.0±0.1	0.75+0.2/-0	180
	2H	5.0	2.5	0.6	TE	4000	5.35±0.2	2.9±0.1	12.0±0.1	4.0±0.1	1.0±0.15	180
PS	I	10.0	5.2	1.6	TEB	3000	10.4±0.1	5.6±0.1	24	8	2.0±0.1	329
	E	6.4	6.4	0.65	TE	2000	6.8±0.1	6.8±0.1	12	8	1.0±0.1	178
TSL	1	6.3	3.1	1	TE	3000	6.6±0.1	3.4±0.1	12.0±0.1	4.0±0.1	1.3±0.1	180
NPR	1	7.5	4.5	2	TE	1000	7.9±0.1	4.8±0.1	16	8.2±0.2	2.45±0.1	178
	2	12	8	4	TEB	1000	13±0.1	9±0.1	24	102	4.35±0.1	330
CSR	1	10.8	6.2	2.1	TE	1000	11.1±0.14	6.7±0.1	24	12.0±0.1	2.6±0.1	255
	2	12.8±0.5	8.2±0.3	3.1±0.2	TE	1000	13.0±0.1	9.0±0.15	24	12.0±0.1	4.35±0.1	330
CZB CZP MCL	1E	1.0±0.1	0.5±0.1	0.5±0.1	TP	10000	1.17±0.1	0.65±0.1	8.0±0.22	2.0±0.23	0.63±0.1	178
	1J	1.6±0.15	0.8±0.15	0.8±0.15	TD	4000	1.8±0.1	1.1±0.1	8.1±0.1	4.0±0.1	1.1±0.1	178
	2A	2.0±0.2	1.25±0.2	0.9±0.2	TE	2000/4000* 3000*	2.4±0.1	1.6±0.1	8.1±0.1	4.0±0.1	1.2±0.1	178
MHL	2B	3.2±0.2	1.6±0.2	0.51±0.25	TE	3000	3.5±0.1	1.8±0.1	8.1±0.1	4.0±0.1	1.8±0.1	178
	1E	1.0±0.1	0.5±0.1	0.5±0.1	TP	10000	1.17±0.1	0.67±0.1	8.0±0.22	2.0±0.23	0.63±0.1	178
MCA	1J	1.6±0.15	0.8±0.15	0.8±0.15	TD	4000	1.85±0.1	1.15±0.1	8.0±0.1	4.0±0.1	1.1±0.1	178
	1E4	2.0±0.15	1.25±0.15	0.6±0.1	TE	4000	2.2±0.1	1.45±0.1	8.0±0.2	4.0±0.1	2.0±0.1	180
KGM	1J4	3.2±0.15	1.6±0.15	0.8±0.1	TD	4000	3.5±0.15	1.9±0.15	8.0±0.2	4.0±0.1	2.5±0.1	180
	0603	1.6±0.2	0.8±0.2	0.6±0.2	TE	4000	1.9±0.05	1.1±0.05	8.0±0.1	4.0±0.1	2.5 max.	178
	0805	2.0±0.2	1.25±0.2	0.8±0.2	TE	4000	2.2±0.1	1.5±0.1	8.0±0.3	4.0±0.1	2.5 max.	178
	1206	3.2±0.2	1.6±0.2	0.8±0.2	TE	2000	3.5±0.1	2.0±0.1	8.0±0.3	4.0±0.1	2.5 max.	178
FBA	1812	4.5±0.3	3.2±0.3	1.0±0.2	TE	1000	4.9±0.1	3.5±0.2	12.0±0.3	4.0±0.1	2.5 max.	178
	1J	3.2±0.2	1.6±0.2	0.8±0.2	TE	3000	3.5±0.1	1.8±0.1	8.1±0.1	4.0±0.1	1.2±0.1	178
NV73 NV73DL	1H	0.6	0.3	0.3	TBM	15000	0.68±0.02	0.38±0.02	8.0±0.2	4.0±0.2	1.75 max.	180
	1E	1.0±0.1	0.5±0.1	0.25±0.15	TP	10000	1.15±0.1	0.65±0.1	8.0±0.2	4.0±0.1	0.6±0.2	180
	1J	1.6±0.15	0.8±0.15	0.8±0.15	TE	2500	1.9±0.1	1.2±0.1	8.0±0.2	4.0±0.1	1.75 max.	180
	2A	2.0±0.2	1.25±0.2	1.3 max.	TE	2500	2.4±0.1	1.6±0.1	8.0±0.2	4.0±0.1	1.75 max.	180
	2B	3.2±0.2	1.6±0.2	1.65 max.	TE	2500	3.6±0.1	2.0±0.1	8.0±0.2	4.0±0.1	1.75 max.	180
	2E	3.2	2.5	1.5 max.	TE	2000	3.5±0.1	2.85±0.1	8.0±0.2	4.0±0.2	1.55 max.	180
	2J	4.5	3.2	2.0 max.	TE	1000	4.9±0.1	3.6±0.1	12.0±0.2	8.0±0.2	2.05 max.	180
	2L	5.7	5.0	2.5 max.	TE	1000	6.0±0.1	5.4±0.1	12.0±0.2	8.0±0.2	2.60 max.	180
LR72	A	10±0.2	5.2	2	TED	2000	1.45±0.2	5.7±0.2	2.0±0.05	8.0±0.10	2.3±0.2	255
	B	10±0.2	3	2	TED	2000	1.45±0.2	3.4±0.2	2.0±0.05	8.0±0.10	2.5±0.2	255
	C	11.2±0.4	3.2±0.4	3.5±0.4	TEB	1500	1.17±0.1	4.3±0.1	24±0.2	8.0±0.1	4.4±0.15	330
HFC	1005	1.0±0.15	0.5±0.1	0.5±0.1	T	10000	1.15±0.03	0.65±0.03	8.0±0.10	2.0±0.05	0.60±0.05	178
	1410	1.4±0.15	1.0±0.1	1.0±0.1	TE	3000	1.60±0.05	1.20±0.05	8.0±0.20	4.0±0.10	1.20±0.10	178
	1608	1.6±0.15	0.8±0.1	0.7±0.2	TE	4000	1.80±0.05	1.00±0.05	8.0±0.20	4.0±0.10	0.75 or 0.95±0.10	178
	1610	1.6±0.15	1.0±0.1	0.85±0.25	TE	3000	1.80±0.05	1.20±0.05	8.0±0.20	4.0±0.10	0.80 or 1.00 or 1.20±0.10	178
	1612	1.6±0.15	1.2±0.1	1.1±0.2	TE	3000	1.80±0.05	1.40±0.05	8.0±0.20	4.0±0.10	1.40±0.10	178
KC	1J	1.6±0.2	0.8±0.2	0.6±0.2	TD	4000	1.9±0.05	1.1±0.05	8.0±0.1	4.0±0.1	0.75±0.04	178
	2AF	2.0±0.2	1.25±0.2	0.8±0.2	TD	4000	2.3±0.1	1.55±0.1	8.0±0.2	4.0±0.1	N/A	178
	2A	2.0±0.2	1.25±0.2	1.6±0.2	TE	2000	2.3±0.1	1.55±0.1	8.0±0.2	4.0±0.1	1.9±0.1	178
	2B	3.2±0.3	1.6±0.3	2.5±0.3	TE	1500	3.5±0.1	2.0±0.1	8.0±0.2	4.0±0.1	2.7±0.1	178
KCR	1206	3.2±0.2	1.6±0.2	0.8±0.2	TE	2000	3.5±0.1	2.0±0.1	8.0±0.3	4.0±0.1	2.5 max.	178
TF	10	1.00	0.5	0.45	TB	10000	1.15±0.05	0.65±0.05	8.0±0.2	4.0±0.1	0.6+0.2/-0	178
	16	1.60	0.8	0.6	TD	5000	1.9±0.1	1.1±0.1	8.0±0.3	4.0±0.1	0.9±0.1	180
CCP	2B	3.20	1.6	1.2	TE	3000	3.5±0.1	1.9±0.1	8.0±0.3	4.0±0.1	1.5±0.1	178
	2E		2.5	2.2	TE	2000	3.5±0.1	2.8±0.1	8.0±0.3	4.0±0.1	2.4±0.1	178
CCF	1N,1F	6.0	2.5	2.5	TE	1000	6.4±0.2	2.7±0.2	12.0±0.3	4.0±0.1	2.9±0.2	178
CR	1J10	3.2±0.1	1.6±0.1	0.65±0.1	TE	4000	3.5±0.1	2.0±0.1	8.0±0.2	4.0±0.1	0.75+0.2/-0.1	178
	2A10	4.0±0.2	2.1±0.2	0.7±0.1			4.4±0.2	2.5±0.2	12.0±0.2	4.0±0.1	1.15±0.2	178
MRGF16	-	11	7.7	2.2	TEB	2000	11.7±0.2	8.2±0.2	24	12	2.4±0.1	330
PGD	1E	1.1	0.75	0.75	TE	4000	3.5±0.1	1.2±0.1	8.0±0.3	4.0±0.1	0.9±0.05	180
	1J	1.6	0.8	0.75	TE	4000	3.5±0.1	1.0±0.1	8.0±0.3	4.0±0.1	0.9±0.05	180
PGE	322	2.5	1.25	1.7	TE	3000	3.3±0.1	1.6±0.1	8.0±0.3	4.0±0.1	1.1±0.05	178
BR	27A	9.0	3.0	1.15	TEB	4000	9.3±0.1	3.3±0.1	24.0±0.3	8.0±0.1	1.8±0.2	330
	36S	9.0	4.0	1.15	TEB	4000	9.3±0.1	3.3±0.1	24.0±0.3	8.0±0.1	1.8±0.2	330
PL	2520	2.5	2.0	0.5	TE	4000	2.9±0.2	2.4±0.2	8.0±0.3	4.0±0.1	1.0±0.15	180
	3225	3.2	2.5	0.5	TE	4000	3.5±0.2	3.0±0.2	8.0±0.3	4.0±0.1	1.0±0.15	180
SF	45	4.5	3.2	0.5	TE	2000	5.0±0.1	3.6±0.1	12	8	1.06±0.1	178

* MCL2A: 0.047µH ~ 2.2µH = TD: 4,000 pcs/reel; 2.7µH ~ 10µH = TE: 3,000 pcs/reel
 CZB2A: <2200Ω=TD:4,000; 2200Ω=TD: 2,000 pcs/reel

Type	Component Size (mm)			Carrier Tape	Quantity/ Reel (Pieces)	Taping (mm)					Reel Size	
	L	W	T			A	B	W	P1	T1		
AA(X)	T16	5.0	6.4	1.0	TEB	2500	5.4±0.1	6.8±0.1	16	8	1.5±0.2	330
AA(X)	T20	6.5	6.4	1.0	TEB	2500	7.1±0.1	6.95±0.1	16	8	1.5±0.2	330
AC(X)	T24	7.8	6.4	1.0	TEB	2500	8.3±0.1	6.95±0.1	16	8	1.5±0.2	330
AP(X)	Q16	4.9	5.99	1.6	TEB	2500	5.3±0.1	6.5±0.1	12	8	2.5±0.2	330
CTX	Q20	8.66	5.99	1.6	TEB	2500	9.0±0.1	6.5±0.1	16	8	2.5±0.2	330
DNA	Q24	8.66	5.99	1.6	TEB	2500	9.0±0.1	6.5±0.1	16	8	2.5±0.2	330
DN(X)	Q28	10.0	5.99	1.6	TEB	2500	3.5±0.1	6.5±0.1	16	8	2.5±0.2	330
EA(X)	N08	4.83	5.99	1.6	TEB	2500	5.3±0.1	6.5±0.1	12	8	2.5±0.2	330
ED(X)	N14	8.66	5.99	1.6	TEB	2500	9.0±0.1	6.5±0.1	16	8	2.5±0.2	330
RD(X)	N16	9.91	5.99	1.6	TEB	2500	10.3±0.1	6.5±0.1	16	8	2.5±0.2	330
R(X)A	W16	10.44	10.36	2.4	TEB	1000	10.7±0.1	10.9±0.1	16	12	2.9±0.2	330
RT(X)	W20	12.7	10.36	2.4	TEB	1000	13.3±0.1	10.9±0.1	24	12	2.9±0.2	330
TF(X)	S03	2.92	2.30	0.95	TE	3000	2.77±0.1	3.15±0.1	8	4	1.3±0.2	180
US(X)	S14	2.92	2.30	0.95	TE	3000	3.5±0.1	3.15±0.1	8	4	1.3±0.2	180
	S05	2.90	2.80	1.0	TE	3000	3.5±0.1	3.4±0.1	8	4	1.3±0.2	180
	S06	2.90	2.80	1.0	TE	3000	3.5±0.1	3.4±0.1	8	4	1.3±0.2	180

Packaging specifications

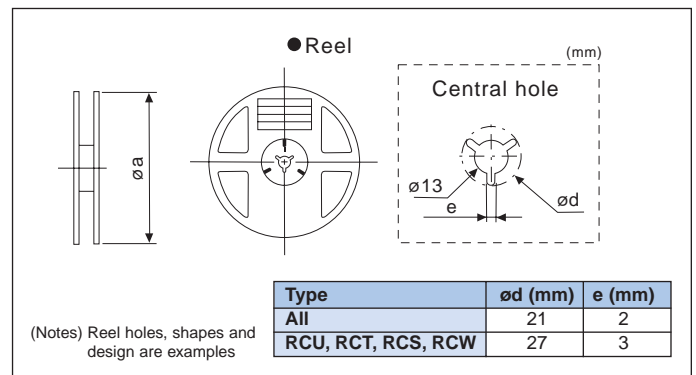
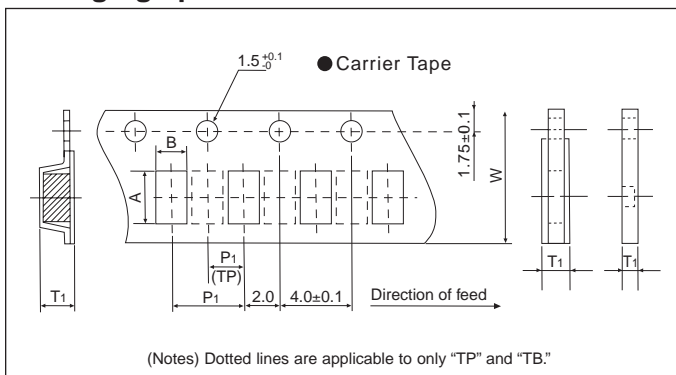

marking

KSE Part Designation		Color		Marking Type
		Body	Marking	
RK73B	1F (01005)	Black	None	None
	1H (0201)	Black	None	None
	1E (0402)	Black	None	None
	1J (0603)	Black	White	3 Digits
	2A (0805)	Black	White	3 Digits
	2B (1206)	Black	White	3 Digits
	2E (1210)	Black	White	3 Digits
	2H (2010)	Black	White	3 Digits
	3A (2512)	Black	White	3 Digits
RK73Z	1H (0201)	Green	None	None
	1E (0402)	Green	None	None
	1J (0603)	Black	White	0
	2A (0805)	Black	White	000
	2B (1206)	Black	White	000
	2E (1210)	Black	White	000
	2H (2010)	Black	White	000
RK73H	1H (0201)	Black	None	None
	1E (0402)	Blue	None	None
	1J (0603)	Blue	Black	E-24 3 Digits, E-96 None
	2A (0805)	Blue	Black	4 Digits
	2B (1206)	Blue	Black	4 Digits
	2E (1210)	Blue	Black	4 Digits
	2H (2010)	Blue	Black	4 Digits
RK73G	1H (0201)	Black	None	None
	1E (0402)	Black	None	None
	1J (0603)	Dark Blue	Black	E-24 3 Digits E-96 None
	2A (0805)	Dark Blue	Black	4 Digits
	2B (1206)	Dark Blue	Black	4 Digits
RK73A	1J (0603)	Black	Light Blue	3 Digits
	2A (0805)	Black	Light Blue	3 Digits
	2B (1206)	Black	Light Blue	3 Digits
RK73N	1E (0402)	Black	None	None
	1J (0603)	Black	None	None
	2A (0805)	Black	None	None
	2B (1206)	Black	None	None
	2E (1210)	Black	None	None
	2H (2010)	Black	None	None
RN73	1E (0402)	Black	None	None
	1J (0603)	Green	Distinctive Colors	E-24 3 digits E-96 None
	2A (0805)	Green	Distinctive Colors	4 Digits
	2B (1206)	Green	Distinctive Colors	4 Digits
	2H (2010)	Green	Distinctive Colors	4 Digits
RN73H/ RN73S	—	Black	Distinctive Colors	4 Digits
HV73	—	Black	White	3 Digits

KSE Part Designation		Color		Marking Type
		Body	Marking	
WK73	—	Black	White	3 Digits
UR73	(D) 1E	Indigo	None	None
	1J	Indigo	White	4 Digits
	(D) 3A	Indigo	White	4 Digits
	(D) 2A	Indigo	White	4 Digits
	(D) 2B	Indigo	White	4 Digits
	(D) 2H	Indigo	White	4 Digits
SG73	—	Red Wine	White	3 Digits
SG73P	—	Green	White	3 Digits
CN	—	Black	White	3 Digits
CN_A	—	Black	White	3 Digits
CN_K	1F, 1H	Black	None	None
	1E	Black	None	None
	1J	Black	White	3 Digits
CNB	—	Black	White	3 Digits + pin number
CND	—	Black	White	3 Digits
CNZ	—	Black	None	None
CNN	—	Green	White	2 Digits
SR73	1E (0402)	Indigo	None	None
	1J (0603)	Indigo	White	1%=4 Digits 2%, 5%=3 Digits
	2A (0805)	Indigo	White	1%=4 Digits 2%, 5%=3 Digits
	2B (1206)	Indigo	White	1%=4 Digits 2%, 5%=3 Digits
	2E (1210)	Indigo	White	1%=4 Digits 2%, 5%=3 Digits
	2H (2010)	Indigo	White	1%=4 Digits 2%, 5%=3 Digits
	3A (2512)	Indigo	White	1%=4 Digits 2%, 5%=3 Digits
SL1-3	—	Black	White	4 Digits
TSL	—	Black	White	4 Digits
TLR	—	Black	White	4 Digits
LR72	—	Silver	None	3 Digits
NPR	—	Black	Teal	1%=4 Digits 5%, 10%=3 Digits
CSR	—	Black	White	3 Digits
RD41B	—	Ivory	3 color band	None
RN41	—	Blue	3 color band	None
RM41	—	Green	3 color band	None
MLT	—	Gray	3 color band	None
CC	—	Brown	None	None
CPCN	—	Gray	None	None
RKC	—	Black	White	1%=4 Digits 2%, 5%=3 Digits
RKH	—	Black	White	1%=4 Digits 2%, 5%=3 Digits
RKL	—	Black	White	1%=4 Digits 2%, 5%=3 Digits
MRP	—	Black	White	Alphanumeric
MRS	—	Black	White	Alphanumeric
LT73	—	Bronze	Black	4 Digits
LA73	—	Orange	Black	3 Digits
NT	1J	Pink	—	—
	2A, 2B	Pink	Black	3 Digits

marking (continued)

KSE Part Designation	Color		Marking Type	
	Body	Marking		
PT72	70°C	Black	None	None
	80°C	Brown	None	None
	100°C	Blue	None	None
RF73	—	Brown	Black	3 Digits
CCP	—	Black	Yellow	2 Digits
CCF	—	White	Black	Alphanumeric
TF	—	Black	White	Letter Designation
NV73	—	Black	None	None
NV73A	—	Black	None	None
NV73D	—	Black	None	None
NVD	—	Green	Black	Alphanumeric
KL73	1H (0201)	Green	White	Direction Only
	1E (0402)	Dark Blue	Yellow	Direction Only
	1J (0602)	Dark Blue	Yellow	Alphanumeric
	2A (0805)	Dark Blue	Yellow	
	2B (1206)	Dark Blue	Yellow	
SDR	0604	Black	Black	3 Digits
	0805	Black	Black	3 Digits
	1006	Black	Black	3 Digits
MCL	—	Black	None	None
MHL	1E	Brown	None	None
	1J	White	Black Stripe	None
KL32	—	Black	White	3 Digits
KQ	0603	Black	White	3 Digits
	0805	Black	White	3 Digits
	1008	Black	White	3 Digits
KQ(T)	0402	White	None	None
KQC	0402/0403	White	None	None
	0603	Black	None	None
LP73	—	Black	White	Alphanumeric
PL	—	Black	White	3 Digits
SDS	—	Black	Black	3 Digits
MRGF	—	Black	White	Alphanumeric
BR	—	Black	White	Alphanumeric
PGD	—	Black	Black	Letter Designation
LPC	—	Black	None	None
HFC	—	Brown	None	None
MCA	—	Tan	None	None
CZB/CZP	—	Black	None	None
KGM	—	Black	None	None
KCR	—	Black	None	None
KC	2A	White/Black	None	None
	1J, 2AF	Brown/Black	None	None
	2B	White/Black	Black	2 Digit
CR	1J	Green	Yellow	3 Digit
	2A	Green	Yellow	3 Digit
FBA	—	Black	None	None
SF	45	Green	White	K + Value

significant figures of nominal resistance

E-12 Decade Values					
10	12	15	18	22	27
33	39	47	56	68	82

E-24 Decade Values					
10	11	12	13	15	16
18	20	22	24	27	30
33	36	39	43	47	51
56	62	68	75	82	91

E-96 Decade Values					
100	102	105	107	110	113
115	118	121	124	127	130
133	137	140	143	147	150
154	158	162	165	169	174
178	182	187	191	196	200
205	210	215	221	226	232
237	243	249	255	261	267
274	280	287	294	301	309
316	324	332	340	348	357
365	374	383	392	402	412
422	432	442	453	464	475
487	499	511	523	536	549
562	576	590	604	619	634
649	665	681	698	715	732
750	768	787	806	825	845
866	887	909	931	953	976

E-192 Decade Values					
100	101	102	104	105	106
107	109	110	111	113	114
115	117	118	120	121	123
124	126	127	129	130	132
133	135	137	138	140	142
143	145	147	149	150	152
154	156	158	160	162	164
165	167	169	172	174	176
178	180	182	184	187	189
191	193	196	198	200	203
205	208	210	213	215	218
221	223	226	229	232	234
237	240	243	246	249	252
255	258	261	264	267	271
274	277	280	284	287	291
294	298	301	305	309	312
316	320	324	328	332	336
340	344	348	352	357	361
365	370	374	379	383	388
392	397	402	407	412	417
422	427	432	437	442	448
453	459	464	470	475	481
487	493	499	505	511	517
523	530	536	542	549	556
562	569	576	583	590	597
604	612	619	626	634	642
649	657	665	673	681	690
698	706	715	723	732	741
750	759	768	777	787	796
806	816	825	835	845	856
866	876	887	898	909	920
931	942	953	965	976	988

standard soldering pad dimensions

The optimum soldering pad dimensions may differ depending on soldering conditions, however, the following land dimensions are generally recommended.

Type	Style	Dimensions millimeters				
		Component Size	A	B	C	D
WK73	2H	2.5 X 5.0	1.0	3.5	5.0	1.25
	2J	3.1 X 4.6	1.6	3.9	4.75	1.15
	3A	3.1 X 6.4	1.6	3.9	6.4	1.15
RK73	1F	0.4 X 0.2	0.12	0.48	0.18	0.18
SG73	1H	0.6 X 0.3	0.25	0.7	0.3	0.225
RN73	1E	1.0 X 0.5	0.5	1.3	0.3	0.4
RN73H	1J	1.6 X 0.8	1.0	2.0	0.6	0.5
SR73	2A	2.0 X 1.25	1.3	2.5	1.05	0.6
LT73	2B	3.2 X 1.6	2.2	4.0	1.4	0.9
NT73	2E	3.2 X 2.5	2.2	4.0	2.3	0.9
PT72	2H	5.0 X 2.5	3.3	6.1	2.3	1.4
LA73	3A	6.4 X 3.2	4.6	8.0	3.0	1.7
RF73	1	6.3 X 3.1	3.4	8.0	3.0	2.3
KL73		11.5 X 7.0	5.4	15.0	5.0	4.8
HV73	2-3	11.5 X 7.0	5.4	15.0	5.0	4.8
LP73	2	11.5 X 7.0	5.0	15.0	6.0	5.0
SDT73	1	7.5 X 4.5	4.0	10.0	3.0	3.0
SL/TSL	2	12.0 X 8.0	8.0	15.0	4.0	3.5
	2E	3.2 X 2.5	2.2	5.0	2.0	1.4
SLN	2B	3.2 X 1.6	2.2	5.0	1.4	1.4
	1N	6.0 X 2.5	3.0	7.2	2.8	2.1
NPR	1F	6.0 X 2.5	3.2	8.8	5.0	2.8
	4045	4.5 X 4.0	1.5	5.1	3.5	1.8
CCP	4325	4.5 X 4.2	1.9	5.5	2.6	1.8
	9040N	9.0 X 4.8	4.0	2.6	3.0	—
	10065	10.0 X 10.4	5.0	13.0	6.0	4.0
	12065	12 X 12.4	5.0	15.0	7.5	5.0
	KL	32	3.2 X 2.5	2.2	5.0	2.0
KQT	0402	1.0 X 0.5	0.46	1.18	0.66	0.36
	0603	1.6 X 1.0	0.64	1.92	1.02	0.64
KQ	0805	2.0 X 1.5	0.76	2.8	1.78	1.02
	1008	2.5 X 2.2	1.27	3.31	2.54	1.02
	1008	2.5 X 2.2	1.27	3.31	2.54	1.02
CZB	1E	0.50 X 0.10	0.4	1.6	0.6	—
	1J	0.80 X 1.6	0.55	2.6	0.94	—
CZP	2A	1.25 X 2.0	0.66	3.0	1.45	—
MHL	2B	1.6 X 3.2	1.5	4.4	1.8	—
MCL	0604	5.6 X 4.5	1.7	6.0	5.8	—
	0805	7.5 X 7.5	2.4	7.8	8.0	2.7
	1006	9.5 X 9.5	2.8	10.0	10.0	3.6
SDR	10	1.0 X 0.5	0.5	1.3	0.3	0.4
	16	1.6 X 0.8	1.0	2.0	0.6	0.5
TF	10	1.0 X 0.5	0.5	1.3	0.3	0.4
	16	1.6 X 0.8	1.0	2.0	0.6	0.5

Flat Type Components

LPC 9040N

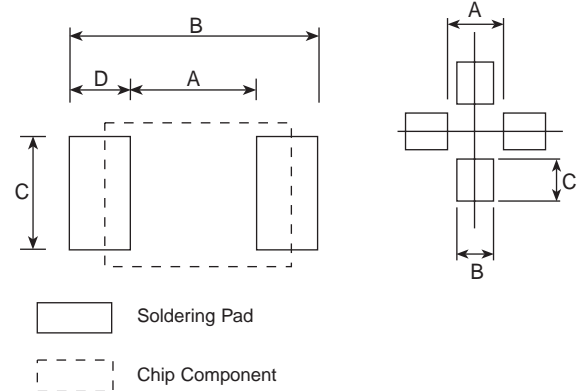

Type	Style	Dimensions millimeters				
		Component Size	A	B	C	D
TLR	2BN, 2B	3.2 X 1.6	1.4	4.0	1.8	1.3
	2H(1mΩ)	5.0 X 2.5	1.0	6.1	3.0	2.55
	2H (2mΩ-6mΩ)	5.0 X 2.5	1.3	6.1	3.0	2.4
	2H (7mΩ-8mΩ)	5.0 X 2.5	3.3	6.1	3.0	1.4
	3A(1mΩ)	6.35 X 3.18	1.45	7.55	3.83	3.05
	3A(2mΩ)	6.35 X 3.18	3.45	7.55	3.83	2.05
	3A(3mΩ)	6.35 X 3.18	2.45	7.55	3.83	2.70
	3A(4mΩ)	6.35 X 3.18	3.45	7.55	3.83	2.05
	3AW (1mΩ-4mΩ)	6.35 X 3.18	1.45	7.55	3.83	3.05
	3AW (5mΩ-8mΩ)	6.35 X 3.18	3.45	7.55	3.83	2.05
UR73	3AW (9mΩ-10mΩ)	6.35 X 3.18	4.40	7.55	3.83	1.575
	2A	2.0 X 1.25	1.3	3.1	1.25	0.9
UR73D	2B	3.2 X 1.6	2.2	4.4	1.6	1.1
	1E	1.0 X 0.5	0.5	1.8	0.5	0.65
	1J	1.6 X 0.8	0.5	2.5	0.9	1.0
	2A	2.0 X 1.25	0.8	3.4	1.3	1.3
	2B	3.2 X 1.6	1.2	4.6	1.8	1.7
	2H (10m-30mΩ)	5.0 X 2.5	1.8	6.1	2.6	2.5
	2H (33m-100mΩ)	5.0 X 2.5	3.3	6.1	2.5	1.4
	3A (10m-30mΩ)	6.4 X 3.2	2.3	8.0	3.3	1.7
	3A (33m-100mΩ)	6.4 X 3.2	4.6	8.0	3.0	1.7

standard soldering pad dimensions (continued)

The optimum soldering pad dimensions may differ depending on soldering conditions, however, the following land dimensions are generally recommended.

Type	Style	Dimensions millimeters				
		Component Size	A	B	C	D
NV73 NV73DL	1H	0.6 X 0.3	0.25-0.35	0.65-0.95	0.25-0.35	0.2-0.3
	1E	1.0 X 0.5	0.51	1.73	0.51	0.61
	1J	1.6 X 0.8	1.0	3.0	1.2	1.0
	2A	2.0 X 1.25	1.2	4.0	1.0	1.4
	2B	3.2 X 1.6	2.2	5.0	1.3	1.4
	2E	3.2 X 2.5	2.2	5.0	2.2	1.4
	2J	4.5 X 3.2	3.0	5.8	2.9	1.4
	2L	5.7 X 5.0	4.5	7.5	4.7	1.5
PL	2520	2.5 X 2.0	1.3	3.3	1.8	1.0
	3225	3.2 X 2.5	2.2	4.0	2.3	0.9
SDS	0804	8.0 X 10.5	5.7	10.5	2.2	2.4
	0805	8.0 X 10.5	5.7	10.5	2.2	2.4
	1003	10.0 X 12.7	7.3	13.3	2.8	3.0
	1005	10.0 X 12.7	7.3	13.3	2.8	3.0
	0908	9.5 X 10.5	10.3	14.7	9.0	2.2
	1205	12.7 X 12.7	6.0	14.0	7.0	4.0
	1206	12.7 X 12.7	6.0	14.0	7.0	4.0
	1208	12.7 X 12.7	6.0	14.0	7.0	4.0
PGD	1E	—	0.016	0.016	0.020	0.052
	1J	—	0.024	0.022	0.020	0.064
PS	I	10.0 X 5.2	5.6	11.0	6.2	2.7
	E	6.4 X 6.4	1.4	7.6	7.0	3.1
SLF	0905	—	9.5	3.74	2.0	1.2

Flat Type Components

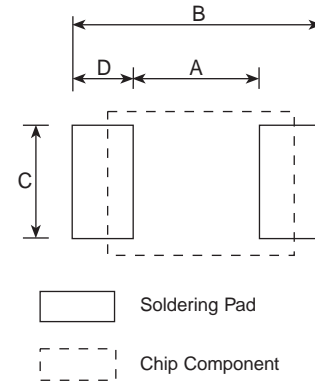

SLF

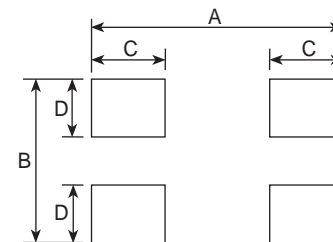

CSR

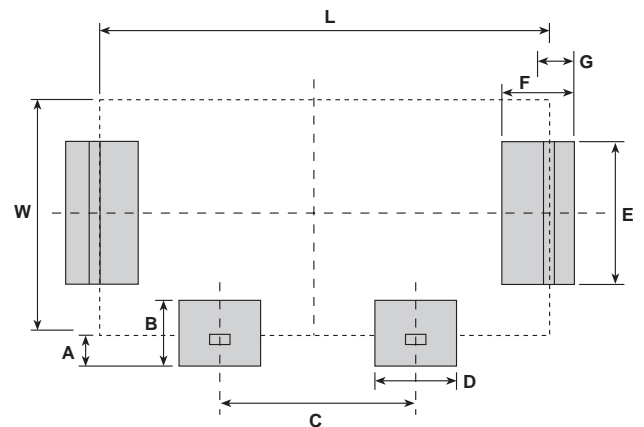

current sense resistor—CSR

Type	Dimensions inches (mm)								
	L	W	A	B	C	D	E	F	G
CSR1	.393 (10.0)	.236 (6.0)	.039 (1.0)	.078 (2.0)	.196 (5.0)	.062 (1.6)	.118 (3.0)	.078 (2.0)	.039 (1.0)
CSR2	.472 (12.0)	.314 (8.0)	.062 (1.6)	.125 (3.2)	.236 (6.0)	.086 (2.2)	.208 (5.3)	.090 (2.3)	.045 (1.15)

resistor arrays—CN

Type	Style	Dimensions						
		Component Size		A	B	C	D	E
		L	W					
CN	1E2K 1E4K	0.5 X n	1.0	0.5	1.5	0.4	0.25	0.67
	1F8K	3.8	1.6	1.0	2.6	0.3	0.5	0.5
	1JA/K	0.8 X n	1.6	1.0	2.6	0.6	0.5	0.8
	2B4A							
	1J	0.8 X n	1.6	0.8	2.6	0.4	0.5	0.8
2A	1.27 X n	2.0	1.0	3.0	0.65	0.5	1.27	
2B								3.2
CND	1J10K	3.2	1.6	0.9	2.6	0.4	0.5	0.64
	2B10	6.4	3.1	2.1	4.1	0.6	0.5	1.27
CNN	2A	2.54	2.0	1.2	2.8	0.6	0.4	1.27

Type	Style	Dimensions							
		Component Size	A	B	C	D	E	F	G
CND	1J10Y	3.2 X 1.6	0.9	2.3	0.3	0.7	0.635	2.45	0.4
CND	2A10Y	4.0 X 2.1	1.0	3.0	0.4	1.0	0.8	3.4	0.4
CNB	2E5Z	3.2 X 2.5	1.7	3.9	0.5	1.1	1.0	0.5	—
CNB	2B9Z	6.4 X 3.2	2.4	4.6	0.5	1.1	1.3	0.65	—

Chip Networks

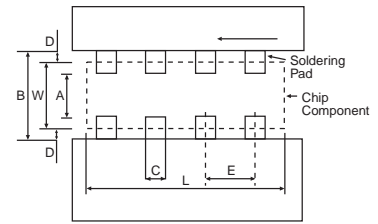

CNB2E5Z, CNB2B9Z

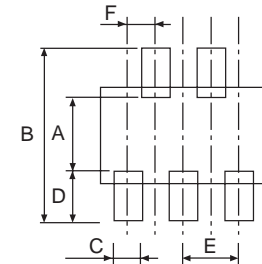

CND1J10Y, CND2A10Y

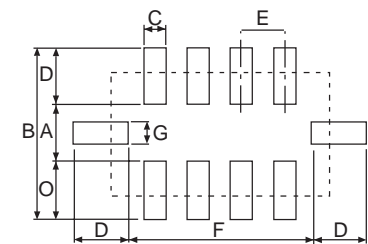

thick film resistor—MRGF

Type	Dimensions					
	Component Size	A	B	C	D	E
MRGF16	11.0 X 7.7	1.27	0.76	0.51	1.27	7.62

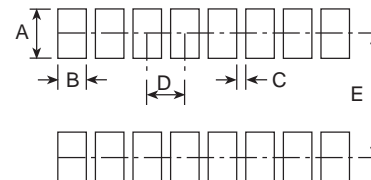

chip resistor array—CR

Dimensions inches (mm)								
L	W	A	B	C	D	E	F	G
1.6	.08	.07	.12	.02	.02	.03	.2	.14
4.0	2.1	1.7	3.1	0.4	0.4	0.8	5.1	3.5

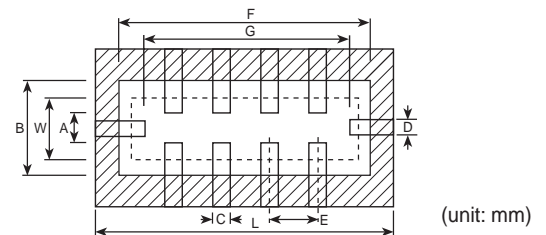

ferrite bead array—FBA

Chip Size	Dimensions inches (mm)					
	Component Size		A	B	C	E
	L	W				
1206 (3216)	.126 (3.2)	.063 (1.6)	.030 (0.762)	.120 (3.048)	.016 (0.406)	.031 (0.787)

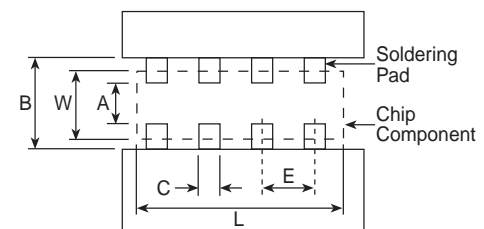

integrated passive devices—SOIC, TSSOP, QSOP & SOT23

Chip Size	Dimensions inches (mm)					
	A	B	C	D	E	F
N08	.028 (0.7)	.050 (1.27)	.094 (2.4)	.098 (2.5)	.287 (7.3)	.150 (3.81)
N14	.028 (0.7)	.050 (1.27)	.094 (2.4)	.098 (2.5)	.287 (7.3)	.300 (7.62)
N16	.028 (0.7)	.050 (1.27)	.094 (2.4)	.098 (2.5)	.287 (7.3)	.350 (8.89)
W16	.028 (0.7)	.050 (1.27)	.094 (2.4)	.272 (6.9)	.461 (11.7)	.350 (8.89)
W20	.028 (0.7)	.050 (1.27)	.094 (2.4)	.272 (6.9)	.461 (11.7)	.450 (11.43)
Q16	.012 (0.3)	.025 (0.63)	.050 (1.27)	.180 (4.56)	.280 (7.1)	.175 (4.45)
Q20	.012 (0.3)	.025 (0.63)	.050 (1.27)	.180 (4.56)	.280 (7.1)	.225 (5.72)
Q24	.012 (0.3)	.025 (0.63)	.050 (1.27)	.180 (4.56)	.280 (7.1)	.275 (6.99)
Q28	.012 (0.3)	.025 (0.63)	.050 (1.27)	.180 (4.56)	.280 (7.1)	.325 (8.26)
SOT23	.035 (0.9)	.037 (0.95)	.055 (1.4)	.031 (0.8)	.141 (3.6)	—
S05	.028 (0.7)	.038 (0.97)	.043 (1.1)	.055 (1.4)	.141 (3.6)	—
S06	.028 (0.7)	.038 (0.97)	.043 (1.1)	.063 (1.6)	.141 (3.6)	.076 (1.9)
S14	.028 (0.7)	—	.055 (1.4)	.031 (0.81)	.141 (3.6)	—

SOIC, TSSOP, QSOP

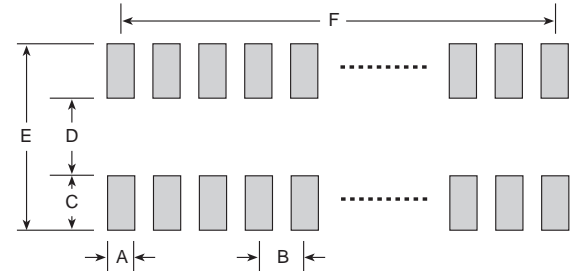

SOT23

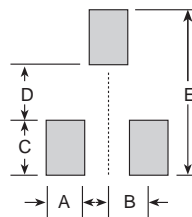

capacitor arrays—MCA

Chip Size	Dimensions inches (mm)				
	Size W	A	B	C	E
0402	.012 (0.31 ± 0.10)	—	.062 (1.59 ± 0.15)	.011 (0.28 ± 0.10)	.019 (0.50 ± 0.10)
0603	.035 (0.89 ± 0.10)	.030 (0.76 ± 0.10)	.099 (2.54 ± 0.15)	.020 (0.45 ± 0.10)	.031 (0.80 ± 0.10)

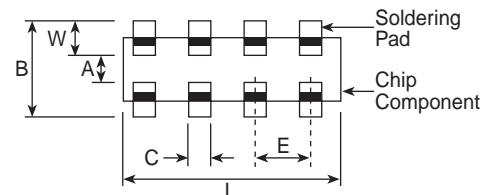

melf type components—RD41, RN41, RM41, MLT, CC

Type	Style	Dimensions millimeters				
		Component Size	A	B	C	D
RD41	2A 10	2.0 X 1.25	1.3	1.3	2.0	1.3
RN41	2B,2E 12	3.5 X 1.45	1.5	2.2	1.5	2.0
RM41	2D 20	3.2 X 1.55	1.5	2.2	1.5	2.0
MLT	2E,2H 25	5.9 X 2.2	2.0	3.0	3.0	4.0

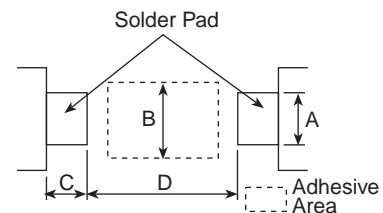

other chips—RCS, RCT, RCU, RCW

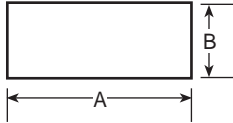

Type	Dimensions millimeters	
	A	B
RCS	4.1-4.3	1.4-1.6
RCT	2.9-3.1	1.05-1.25
RCU	2.5-2.7	0.6-0.8
RCW	4.1-4.3	1.4-1.6

ceramic chip capacitors

Component pads should be designed to achieve good solder fillets and minimize component movement during reflow soldering. Pad dimensions are given below for multilayer ceramic capacitors for both reflow and wave soldering. The basis for these designs is:

- Pad width equal to component width. It is permissible to decrease this to as low as 85% of component width but it is not advisable to go below this.
- Pad overlap 0.5mm beneath component
- Pad extension 0.5mm beyond components for reflow and 1.0mm for wave soldering

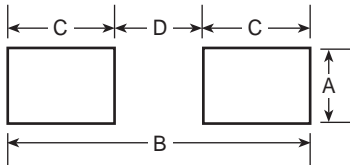

Case Size	Dimensions inches (mm)			
	A	B	C	D
0402	0.02 (0.50)	0.07 (1.70)	0.02 (0.60)	0.02 (0.50)
0603	0.03 (0.75)	0.09 (2.30)	0.03 (0.80)	0.03 (0.70)
0805	0.05 (1.25)	0.12 (3.00)	0.04 (1.00)	0.04 (1.00)
1206	0.06 (1.60)	0.16 (4.00)	0.04 (1.00)	0.09 (2.00)
1210	0.10 (2.50)	0.16 (4.00)	0.04 (1.00)	0.09 (2.00)

ceramic chip capacitors—HFC

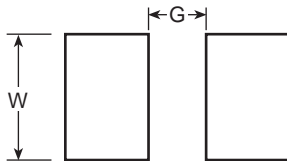

Type	Part	Dimensions inches (mm)	
		G	W
HFC	1005	0.015 (0.40)	0.020 (0.50)
	1410	0.031 (0.80)	0.039 (1.00)
	1608	0.039 (1.00)	0.031 (0.80)
	1610	0.039 (1.00)	0.039 (1.00)
	1612	0.039 (1.00)	0.047 (1.20)

three-terminal inductor/capacitor—KC

Chip Mounting Side

1J, 2AF, 2B

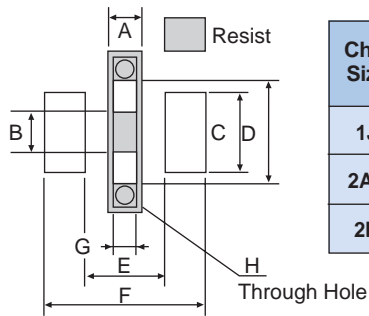

Chip Size	Dimensions inches (mm)							
	A	B	C	D	E	F	G	H
1J	.024 (0.6)	.020 (0.5)	.039 (1.0)	.055 (1.4)	.047 (1.2)	.094 (2.4)	.016 (0.4)	.012 (0.3)
2AF	.024 (0.6)	.028 (0.7)	.055 (1.4)	.071 (1.8)	.055 (1.4)	.110 (2.8)	.016 (0.4)	.012 (0.3)
2B	.040 (1.0)	.055 (1.4)	.071 (1.8)	.110 (2.8)	.087 (2.2)	.157 (4.0)	.031 (0.8)	.020 (0.5)

Back Side

2A

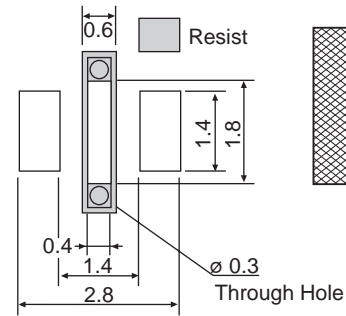

Connect to ground pattern of mounting side

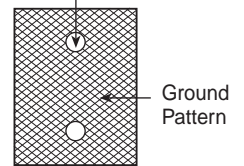

three-terminal capacitor/resistor—KCR

Chip Mounting Side

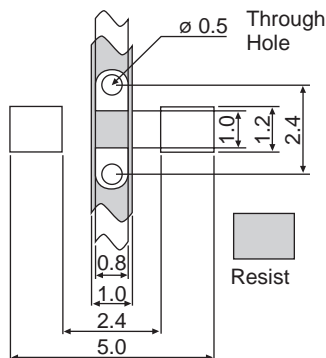

Back Side

Connect to ground pattern of mounting side

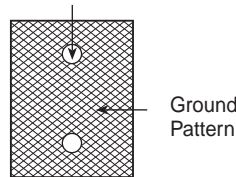

three-terminal capacitor—KGM

0603 Chip Mounting Side

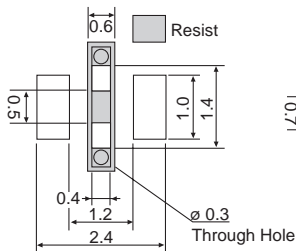

0805 Chip Mounting Side

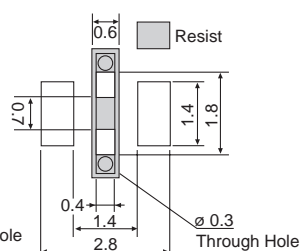

1206 Chip Mounting Side

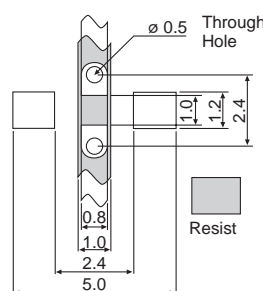

1812 Chip Mounting Side

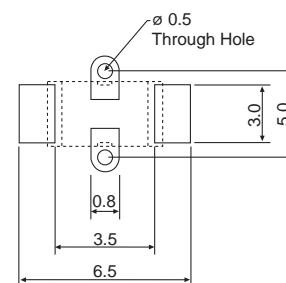

0603, 0805, 1206, 1812 Back Side

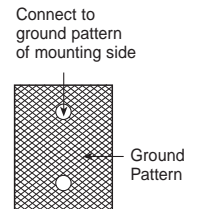

(unit: mm)